

***ANSI/UL ARCHITECTURAL
HARDWARE***



DOOR CLOSERS

ITEM CODE: DC1600 RANGE

FEATURES:

- Fixed power size 2 or 3. Standard sweep and latching speed.
- UL listed. UL10C 3 hours fire rated.
- UL file #: GVEV.R39005.
- Cast aluminium body.
- Standard in package: tri-packed for regular arm, top jamb and parallel arm application.
- Optional feature: Hold open arm.
- Standard finish: Silver (Aluminium- SE).
- Other finishes are available upon request.



MOUNTING STYLES

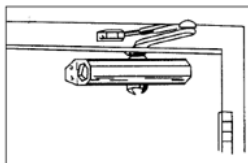

REGULAR ARM INSTALLATION
CLOSER IS INSTALLED ON
PULL/HINGE SIDE OF DOOR

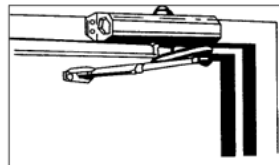

TOP JAMB INSTALLATION
CLOSER IS INSTALLED ON FRAME ON
PUSH SIDE OF DOOR

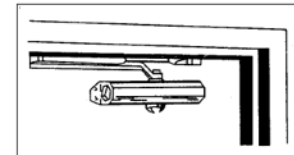

PARALLEL ARM INSTALLATION
CLOSER IS INSTALLED ON
PUSH SIDE OF DOOR

TECHNICAL DIMENSIONS

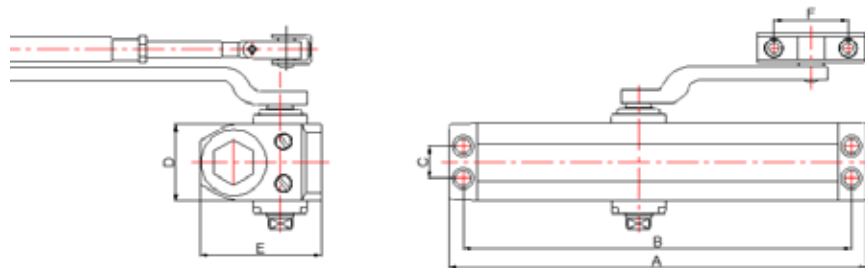

DESCRIPTION		DIMENSIONS
A.	Length of closer body	225 mm
B.	Horizontal Mounting Holes	208 mm
C.	Vertical Mounting Holes	19 mm
D.	Closer body height	50 mm
E.	Projection from door	73 mm
F.	Arm shoe spacing	44 mm

SELECTION CHART				
Model#	CLOSER SIZE	STANDARD & TOP JAMB MINIMUM - MAXIMUM WIDTH OF DOOR (MM)		MAX. DOOR WEIGHT (KG)
		INTERIOR	EXTERIOR OR VESTIBULE DOORS	
DC1602	2	609 to 863.6		36
DC1603	3	863.6 to 965.5	609 to 762	45

Model#	CLOSER SIZE	PARALLEL ARM MAXIMUM WIDTH OF DOOR (MM)		MAX. DOOR WEIGHT (KG)
		INTERIOR	EXTERIOR OR VESTIBULE DOORS	
DC1602	2			
DC1603	3	609 to 863.6		36

OPTIONAL ACCESSORIES		
DESCRIPTION	PHOTO	ARTICLE #
Friction Type-Hold open arm.		FTHO
Parallel Arm Bracket for FTTHO		PAB
Slim Plastic Cover		SPC
Sex Nuts- 4 PCS/PACK		SN
Parallel Arm Bracket		PABX
Extended Long Rod and Shoe Length 358.8 mm Top jamb reveal: 4 inches thru 8 inches		ELRS

ITEM CODE: DC1700 RANGE



FEATURES:

- Fixed power size 3, 4 or 5 and adjustable power size 1-4, 1-5, 3-6 or 2-6.
- Standard sweep and latching speed.
- UL listed. UL10C 3 hours fire rated.
- UL file #: GVEV.R39005
- ADA compliant (American with Disabilities Act), extracted from ICC (International Code Council) A117.1. Meets 5 lbs opening force for DC1714.
- Closer body in: Cast aluminium. Closer arm in: Stamped steel. Non-handed.
- Available with or without adjustable backcheck.
- Standard in package: tri-packed for regular arm, top jamb and parallel arm application.
- Standard self-tapping and drilling screws.
- Standard finish: Silver (Aluminium- SE).
- Other finishes are available upon request.



MOUNTING STYLES

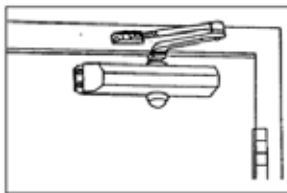

REGULAR ARM INSTALLATION
CLOSER IS INSTALLED ON
PULL/HINGE SIDE OF DOOR

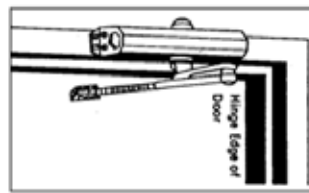

TOP JAMB INSTALLATION
CLOSER IS INSTALLED ON FRAME ON PUSH SIDE
OF DOOR

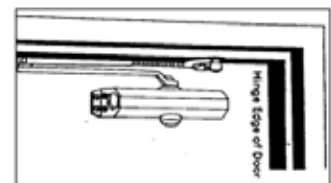

PARALLEL ARM INSTALLATION
CLOSER IS INSTALLED ON
PUSH SIDE OF DOOR

TECHNICAL DIMENSIONS

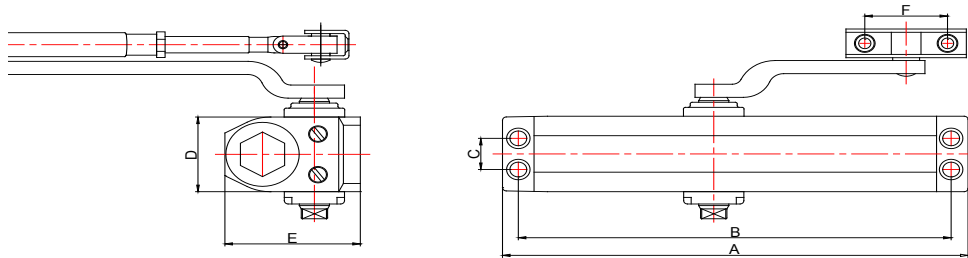

A. LENGTH OF CLOSER BODY: 248 MM	B. HORIZONTAL MOUNTING HOLES: 230 MM
C. VERTICAL MOUNTING HOLES: 19 MM	D. CLOSER BODY HEIGHT: 50 MM
E. PROJECTION FROM DOOR: 73 MM	F. ARM SHOE SPACING: 44 MM

SELECTION CHART

MODEL#	ANSI CLOSER SIZE	REMARK
DC1703	3	Tri-Packed
DC1704	4	Tri-Packed
DC1705	5	Tri-Packed
DC1714	1-4	Tri-Packed, with backcheck, ADA compliant, BHMA CERTIFIED
DC1715	1-5	Tri-Packed with Backcheck, BHMA CERTIFIED
DC1716	1-6	Tri-Packed with Backcheck
DC1736	3-6	Tri-Packed with Backcheck

CLOSER SIZE	REGULAR & TOP JAMB MINIMUM - MAXIMUM WIDTH OF DOOR(MM)		MAX. DOOR WEIGHT (KG)
	INTERIOR	EXTERIOR OR VESTIBULE DOORS	
2	609 to 863.6		36
3	863.6 to 965.5	609 to 762	45
4	965.5 to 1219.2	762 to 914.4	57
5	1219.2 to 1371.6	914.4 to 1066.8	70
6	1371.6 to 1524	1066.8 to 1219.2	82

CLOSER SIZE	PARALLEL ARM MINIMUM - MAXIMUM WIDTH OF DOOR(MM)		MAX. DOOR WEIGHT (KG)
	INTERIOR	EXTERIOR OR VESTIBULE DOORS	
2			
3	609 to 863.6		36
4	863.6 to 965.5	609 to 762	45
5	965.5 to 1219.2	762 to 914.4	57
6	1219.2 to 1371.6	914.4 to 1066.8	70

OPTIONAL ACCESSORIES		
DESCRIPTION	PHOTO	ARTICLE #
3 ½ inches Tall Drop Plate Parallel Arm Mount		DC1700-TDP-3.5
2 9/16 inches Tall Narrow Drop Plate		DC1700-TNDP-2916
Friction Type-Hold open arm.		FTHO
Parallel Arm Bracket for FTHO		PAB
Slim Plastic Cover		SPC
Sex Nuts- 4 PCS/PACK		SN
Extended Long Rod and Shoe Length 358.8 mm Top jamb reveal: 4 inches thru 8 inches		ELRS
Parallel Arm Bracket		PABX

ITEM CODE: DC1916 RANGE



FEATURES:

- Adjustable power size 1 - 6. Standard sweep and latching speed.
- UL listed. UL10C 3 hours fire rated.
- UL file #: GVEV.R39005
- Tested to meet ANSI A156.4 Grade 1.
- BHMA CERTIFIED for DC1916 & DC1916DA.
- ADA compliant (American with Disabilities Act), extracted from ICC (International Code Council) A117.1. Meets 5 lbs opening force for DC1916 and DC1916DA.
- Closer body in: Cast aluminium. Closer arm in: Stamped steel. Non-handed.
- Standard in package: tri-packed for regular arm, top jamb and parallel arm application.
- Standard self-tapping, sex nuts and ABS cover.
- Standard backcheck.
- Standard finish: Silver (Aluminium-SE).
- Other finishes are available upon request.



MOUNTING STYLES

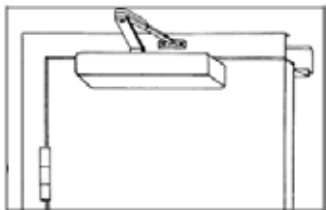

Regular arm-Pull Side

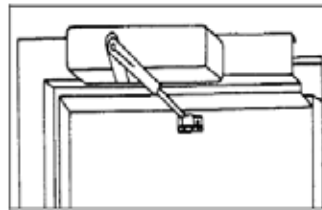

Top Jamb-Push Side

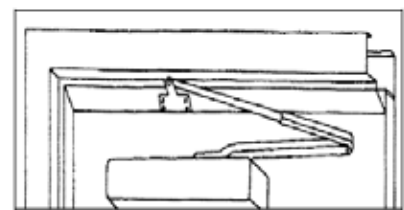

Parallel arm-Push Side

TECHNICAL DIMENSIONS

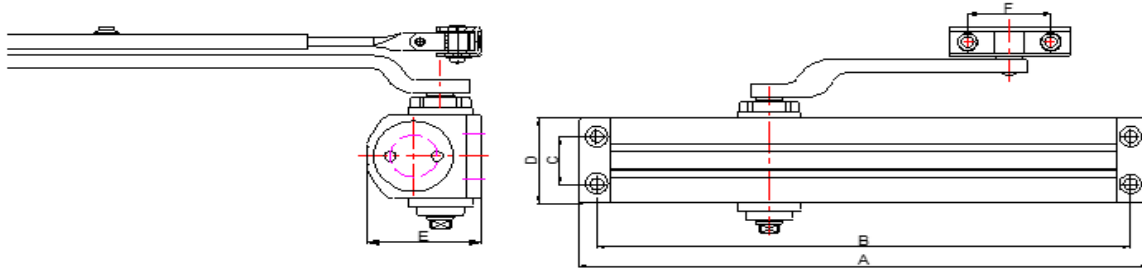





A. LENGTH OF CLOSER BODY: 302 MM	B. HORIZONTAL MOUNTING HOLES : 282.5 MM
C. VERTICAL MOUNTING HOLES: 19 MM	D. CLOSER BODY HEIGHT: 51 MM
E. PROJECTION FROM DOOR: 60 MM	F. ARM SHOE SPACING: 44 MM

SELECTION CHART

Model#	ANSI CLOSER SIZE	REMARK
DC1916	1-6	Tri-Packed, Backcheck, ADA compliant, BHMA CERTIFIED
DC1916DA	1-6	Tri-Packed, Backcheck, Delayed Action, ADA compliant, BHMA CERTIFIED

CLOSER SIZE	REGULAR & TOP JAMB MINIMUM - MAXIMUM WIDTH OF DOOR(MM)		MAX. DOOR WEIGHT (KG)
	INTERIOR	EXTERIOR OR VESTIBULE DOORS	
2	609 to 863.6		36
3	863.6 to 965.5	609 to 762	45
4	965.5 to 1219.2	762 to 914.4	57
5	1219.2 to 1371.6	914.4 to 1066.8	70
6	1371.6 to 1524	1066.8 to 1219.2	82

CLOSER SIZE	PARALLEL ARM MINIMUM - MAXIMUM WIDTH OF DOOR(MM)		MAX. DOOR WEIGHT (KG)
	INTERIOR	EXTERIOR OR VESTIBULE DOORS	
2			
3	609 to 863.6		36
4	863.6 to 965.5	609 to 762	45
5	965.5 to 1219.2	762 to 914.4	57
6	1219.2 to 1371.6	914.4 to 1066.8	70

OPTIONAL ACCESSORIES		
DESCRIPTION	PHOTO	ARTICLE #
Regular or Top Jamb Narrow Drop Plate (2" Tall)		DC1900-RTJNDP
Parallel Arm Drop Plate (3 9/16" Tall)		DC1900-PADP
Friction Type-Hold open arm.		FTHO
Parallel Arm Bracket for FTHO		PAB
Heavy Duty Parallel Arm with Dead Stop		DC1900-PADS
Heavy Duty Parallel Arm with Spring Cush Dead Stop		DC1900-PASCDS
Heavy Duty Hold Open Parallel Arm with Dead Stop		DC1900-HOPADS

OPTIONAL ACCESSORIES		
DESCRIPTION	PHOTO	ARTICLE #
Heavy Duty Hold Open Parallel Arm with Spring Cush Dead Stop		DC1900-HOPASCDs
Spring Cushion for Cush or Cush Hold Open Arm		5590
Metal Cover		DC1900-MC
Blade Stop Spacer		1719-BSS
Extended Long Rod and Shoe Length 343.6 mm Top jamb reveal: 4 inches thru 8 inches		19-ELR
Sex Nuts- 4 PCS/PACK		SN
Parallel Arm Bracket		PABX

ITEM CODE: DC6203G



FEATURES:

- Fixed power size 3.
- UL listed. UL10C 3 hours fire rated.
- UL file #: GVEV.R39005.
- Cast aluminium body. Non-handed.
- Standard sweep, latching speed, hold open function and guide rail.
- Regular and transom mounting installation.
- Standard finish: Silver (Aluminium-SE).
- Other finishes are available upon request.



MOUNTING STYLES			
STANDARD		TRANSOM	

TECHNICAL DIMENSIONS	

MODEL#	CLOSER SIZE	MAX. DOOR WEIGHT (KG)	MAXIMUM WIDTH OF DOOR(MM)
DC6203G	3	45	863.6 to 965.5

ITEM CODE: DC6224BCG

FEATURES:

- Overhead concealed cam action door closer.
- Adjustable power size 2-4.
- Standard adjustable sweep and latching speed.
- UL listed. UL10C 3 hours fire rated.
- Tested to meet ANSI A156.4 Grade 3. UL file # FUOR.R39005
- UL file #: GVEV.R39005.
- BHMA CERTIFIED.
- Extruded aluminium body.
- Maximum opening angle 120 degree.
- Standard adjustable backcheck. Guide rail. Non- handed.
- Suitable for door thickness 44 mm and above. Standard wood and machine screws pack.
- Standard finish: Silver (Aluminium- SE).
- Other finishes are available upon request.



MOUNTING STYLES

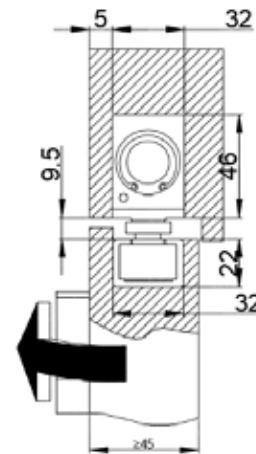
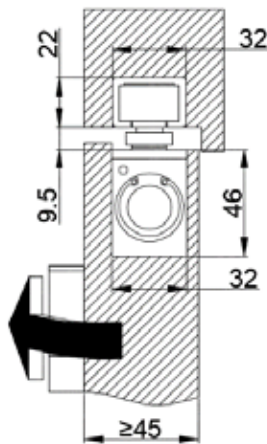

TECHNICAL DIMENSIONS

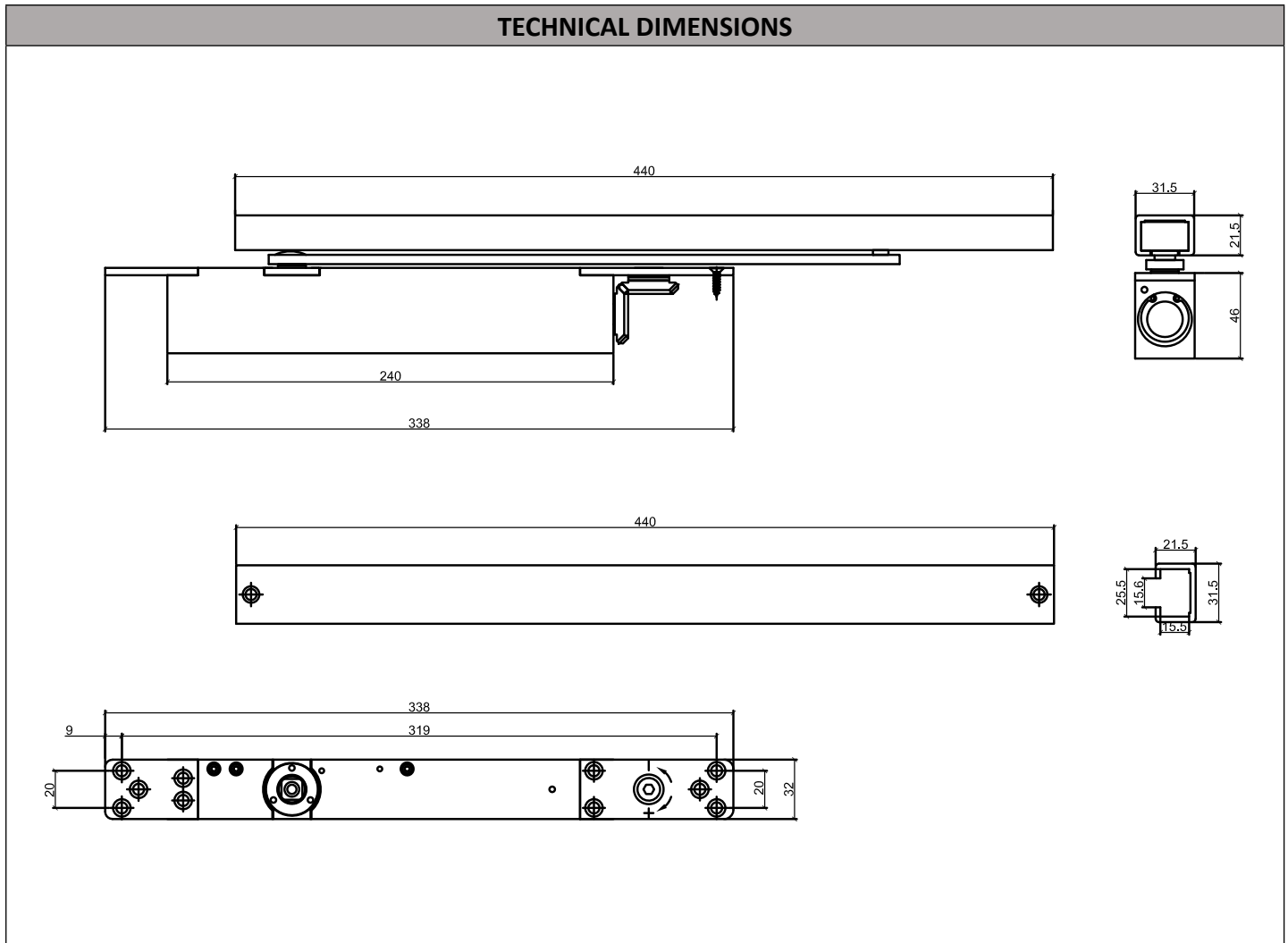

MODEL#	CLOSER SIZE	MAX. DOOR WEIGHT (KG)	MAXIMUM WIDTH OF DOOR(MM)
DC6224BCG	2-4	36 - 57	609.6 - 965

ITEM CODE: DC8316 RANGE

FEATURES:



- Adjustable power size 1-6.
- Standard sweep and latching speed.
- UL listed. UL10C 3 hours fire rated.
- UL file #: GVEV.R39005
- Tested to meet ANSI A156.4 Grade 1.
- ADA compliant (American with Disabilities Act), extracted from ICC (International Code Council) A117.1.
- BHMA CERTIFIED
- Stainless steel covers are available.
- Closer projection: 56 mm.
- Closer body in: Cast aluminium. Closer arm in: Stamped steel. Non-handed.
- Standard adjustable backcheck, full cover, self-tapping and drilling screws, sex nuts & bolts.
- Available with slide arm/guide rail.
- Standard tri-packed for regular arm, top jamb and parallel arm application.
- Optional features: delayed action.
- Standard finish: Silver (Aluminium-SE).
- Other finishes are available upon request.



MOUNTING STYLES

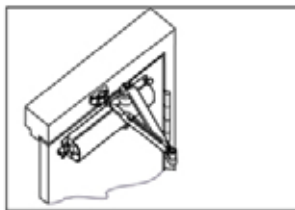

REGULAR ARM INSTALLATION
CLOSER IS INSTALLED ON PULL/HINGE
SIDE OF DOOR

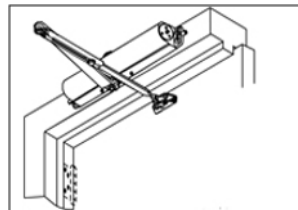

TOP JAMB INSTALLATION
CLOSER IS INSTALLED ON FRAME ON
PUSH SIDE OF DOOR

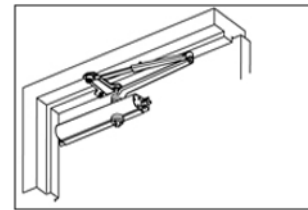

PARALLEL ARM INSTALLATION
CLOSER IS INSTALLED ON PUSH SIDE OF
DOOR

TECHNICAL DIMENSIONS

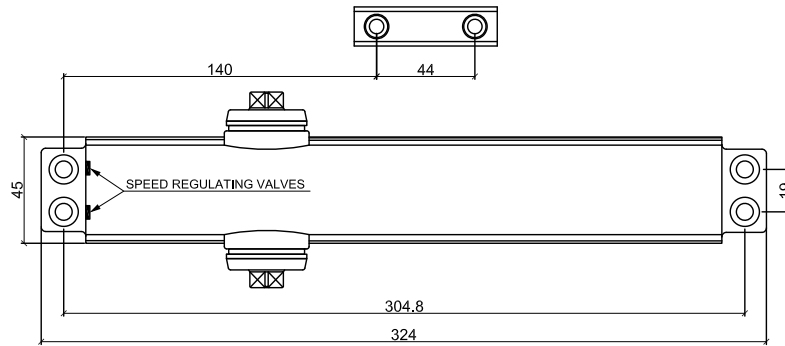

SELECTION CHART

MODEL#	ANSI CLOSER SIZE	REMARK
DC8316	1-6	Tri-Packed, Backcheck, ADA compliant, BHMA CERTIFIED
DC8316DA	1-6	Tri-Packed, Backcheck, delayed action, ADA compliant, BHMA CERTIFIED
DC8316BC-G	1-6	Tri-Packed, Backcheck, effective power size 1-4 due to guide rail installation, with hold open function

CLOSER SIZE	REGULAR & TOP JAMB MINIMUM - MAXIMUM WIDTH OF DOOR(MM)		MAX. DOOR WEIGHT (KG)
	INTERIOR	EXTERIOR OR VESTIBULE DOORS	
2	609 to 863.6		36
3	863.6 to 965.5	609 to 762	45
4	965.5 to 1219.2	762 to 914.4	57
5	1219.2 to 1371.6	914.4 to 1066.8	70
6	1371.6 to 1524	1066.8 to 1219.2	82

CLOSER SIZE	PARALLEL ARM MINIMUM - MAXIMUM WIDTH OF DOOR(MM)		MAX. DOOR WEIGHT (KG)
	INTERIOR	EXTERIOR OR VESTIBULE DOORS	
2			
3	609 to 863.6		36
4	863.6 to 965.5	609 to 762	45
5	965.5 to 1219.2	762 to 914.4	57
6	1219.2 to 1371.6	914.4 to 1066.8	70

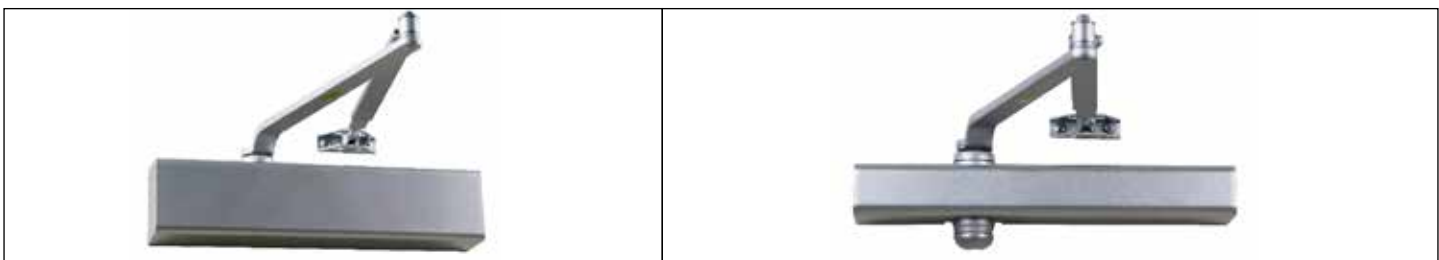

OPTIONAL ACCESSORIES		
DESCRIPTION	PHOTO	ARTICLE #
Drop Plate for Regular Arm mounting		83-DPRA
Drop Plate for Top Jamb mounting		83-DPTJ
Drop Plate for Parallel Arm mounting		83-DPPA
Friction Type-Hold Open Arm		83-FHOA
Parallel Arm Bracket for 83-FHOA		PAB
Adjustable Hold Open Arm		9689-AHO
Heavy Duty Parallel Arm with Dead Stop		9689-CSA

OPTIONAL ACCESSORIES		
DESCRIPTION	PHOTO	ARTICLE #
Heavy Duty Parallel Arm with Spring Cush Dead Stop		9689-SCDS
Heavy Duty Hold Open Parallel Arm with Dead Stop		9689-CSHO
Heavy Duty Hold Open Parallel Arm With Spring Cush Dead Stop		9689-CSHO-5950
Friction Type hold open Arm (Push side)		96-FHO
Cush Stop Arm With Regular Arm		9689-ISF
Spring Cushion for Cush or Cush Hold Open Arm		5590
Slim Plastic Cover		96-C-SP

OPTIONAL ACCESSORIES		
DESCRIPTION	PHOTO	ARTICLE #
Stainless Steel Cover		83-SS
Sex Nuts- 4 PCS/PACK		SN
Blade Stop Spacer		1719-BSS
Extended Long Rod and Shoe Length 343.6 mm Top jamb reveal: 4 inches thru 8 inches		19-ELR
Parallel Arm Bracket		PABX

ITEM CODE: DC8416 RANGE



FEATURES:

- Adjustable power size 1 - 6.
- Standard sweep and latching speed.
- UL listed. UL10C 3 hours fire rated.
- UL file number: GVEV.R39005.
- Tested to meet ANSI A156.4 Grade 1.
- ADA Compliant (American with Disabilities Act), extracted from ICC (International Code Council) A117.1. Meets 5 lbs opening force for DC8416 and DC8416DA.
- BHMA CERTIFIED.
- Projection from door: 51 mm
- Closer body in: Cast Iron. Closer arm in: Forget Steel. Non-handed.
- Standard backcheck and full plastic cover.
- Standard tri-packed for regular arm, top jamb and parallel arm application.
- Standard packing including sex nuts and bolts.
- Optional features: Delayed action.
- Standard finish: Silver (Aluminium-SE).
- Other finishes are available upon request.



MOUNTING STYLES

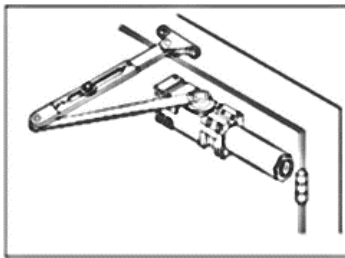

Regular arm -Pull Side

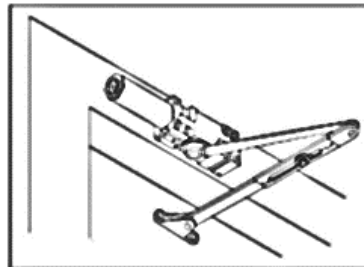

Top Jamb -Push Side

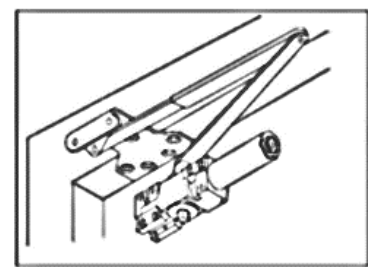

Parallel arm-Push Side

TECHNICAL DIMENSIONS

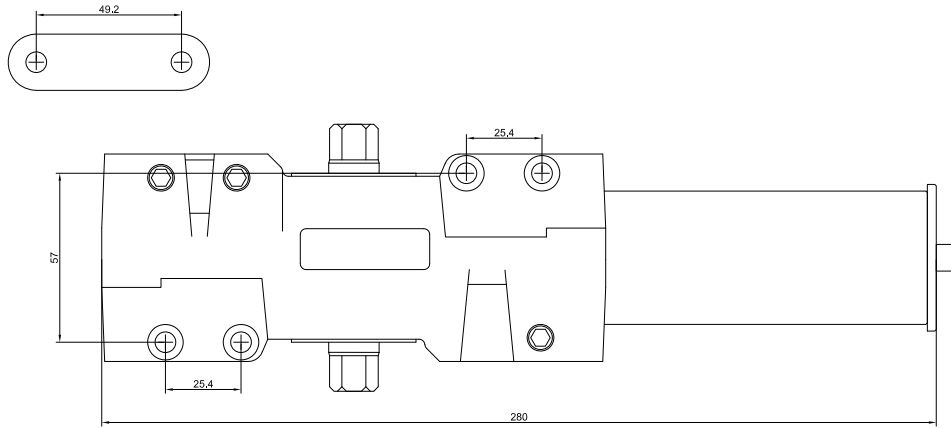







A. LENGTH OF CLOSER BODY: 280 MM	B. HORIZONTAL MOUNTING HOLES: 25.4 MM
C. VERTICAL MOUNTING HOLES: 57 MM	D. CLOSER BODY HEIGHT: 70 MM
E. PROJECTION FROM DOOR: 51 MM	F. ARM SHOE SPACING: 49.2 MM

SELECTION CHART

Model#	ANSI CLOSER SIZE	REMARK
DC8416	1-6	Tri-Packed, Backcheck, ADA compliant, BHMA CERTIFIED
DC8416DA	1-6	Tri-Packed, backcheck, Delayed Action, ADA compliant, BHMA CERTIFIED

CLOSER SIZE	REGULAR & TOP JAMB		MAX. DOOR WEIGHT (KG)
	MINIMUM - MAXIMUM WIDTH OF DOOR(MM)		
	INTERIOR	EXTERIOR OR VESTIBULE DOORS	
2	609 to 863.6		36
3	863.6 to 965.5	609 to 762	45
4	965.5 to 1219.2	762 to 914.4	57
5	1219.2 to 1371.6	914.4 to 1066.8	70
6	1371.6 to 1524	1066.8 to 1219.2	82

CLOSER SIZE	PARALLEL ARM		MAX. DOOR WEIGHT (KG)
	MINIMUM - MAXIMUM WIDTH OF DOOR(MM)		
	INTERIOR	EXTERIOR OR VESTIBULE DOORS	
2			
3	609 to 863.6		36
4	863.6 to 965.5	609 to 762	45
5	965.5 to 1219.2	762 to 914.4	57
6	1219.2 to 1371.6	914.4 to 1066.8	70

OPTIONAL ACCESSORIES		
DESCRIPTION	PHOTO	ARTICLE #
<p>Drop Plate-Regular arm Mount Required for hinge side mount when top rail is less than 3 3/4" Plate require 2" minimum top rail</p>		84-DPRA
<p>Drop Plate-Low Clearance For use when ceiling clearance prevents normal top jamb mounting For use when overhead door holder prevents normal top jamb mounting</p>		84-DPLR
<p>Drop Plate-Pop Jamb mount Required for top jamb when frame face is less than 3 1/2" (89mm) Plate require 1 3/4" minimum frame face For use with plastic cover</p>		84-DPPJ
<p>Drop Plate-Parallel Arm mount Required for parallel arm when top rail is less than 5 1/2", measured from the stop Plate require 2" minimum top rail</p>		84-DPPA
<p>Friction type-Hold open arm With P.A.B</p>		84-FHOA
<p>Parallel Arm Bracket for 84-FHOA</p>		PAB
<p>Heavy Duty Parallel Arm</p>		84-HDPA

OPTIONAL ACCESSORIES		
DESCRIPTION	PHOTO	ARTICLE #
Heavy Duty Parallel Arm with Dead Stop		84-CSA
Heavy Duty Parallel Arm with Spring Cush Dead Stop		8489-SCDS
Heavy Duty Hold Open Parallel Arm with Dead Stop		8489-CSHO
Heavy Duty Hold Open Parallel Arm with Spring Cush Dead Stop		8489-CSHO-5950
Stainless Steel Cover		84-SS
Spring Cushion for Cush or Cush Hold Open Arm		5590
Blade Door Spacer		1720-Bss

OPTIONAL ACCESSORIES		
DESCRIPTION	PHOTO	ARTICLE #
Cush Shoe Support		84-CSS
Extended Long Rod and Shoe Length 217.1 mm Top jamb reveal: 2 5/8 inches thru 4 13/16 inches		84-ELR
Extra Extended Long Rod and Shoe Length 314 mm Top jamb reveal: 4 7/8 inches thru 8 inches		84-EELR

ITEM CODE: DC8900 RANGE



FEATURES:

- Fixed power size 3, 4 or 5 and adjustable power
- Size 1-4, 1-5, 1-6 or 3-6.
- Standard sweep and latching speed.
- UL listed (all models). UL10C 3 hours fire rated.
- UL file #: GVEV.R39005
- Tested to meet ANSI A156.4 Grade 1.
- ADA compliant (American with Disabilities Act), extracted from ICC (International Code Council) A117.1. Meets 5 lbs opening force.
- BHMA CERTIFIED.
- Stainless steel covers are available. Guide rail is available.
- Closer body in: Cast aluminium. Closer arm in: Forged steel.
- Non-handed.
- Standard adjustable backcheck.
- Standard tri-packed for regular arm, top jamb and parallel arm application.
- Standard self-tapping and drilling screws.
- Standard finish: Silver (Aluminium- SE).
- Other finishes are available upon request.



MOUNTING STYLES

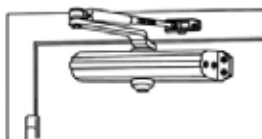

REGULAR ARM INSTALLATION
CLOSER IS INSTALLED ON PULL/HINGE
SIDE OF DOOR



TOP JAMB INSTALLATION
CLOSER IS INSTALLED ON FRAME ON
PUSH SIDE OF DOOR

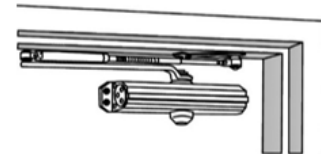

PARALLEL ARM INSTALLATION
CLOSER IS INSTALLED ON PUSH SIDE OF
DOOR

TECHNICAL DIMENSIONS

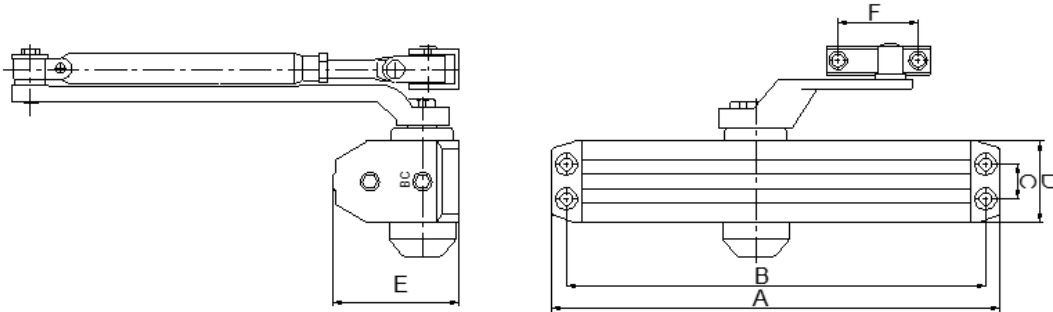

A. LENGTH OF CLOSER BODY: 248 MM	B. HORIZONTAL MOUNTING HOLES: 230 MM
C. VERTICAL MOUNTING HOLES: 19 MM	D. CLOSER BODY HEIGHT: 46 MM
E. PROJECTION FROM DOOR: 70 MM	F. ARM SHOE SPACING: 44 MM

MODEL#	ANSI CLOSER SIZE	REMARK
DC8902	2	Tri-Packed
DC8903	3	Tri-Packed
DC8903BC	3	Tri-Packed with Backcheck
DC8904BC	4	Tri-Packed with Backcheck
DC8905BC	5	Tri-Packed with Backcheck
DC8914BC	1-4	Tri-Packed with Backcheck, ADA compliant
DC8915BC	1-5	Tri-Packed with Backcheck
DC8936BC	3-6	Tri-Packed with Backcheck
DC8916BC	1-6	Tri-Packed with Backcheck, BHMA CERTIFIED

CLOSER SIZE	REGULAR & TOP JAMB MINIMUM - MAXIMUM WIDTH OF DOOR(MM)		MAX. DOOR WEIGHT (KG)
	INTERIOR	EXTERIOR OR VESTIBULE DOORS	
2	609 to 863.6		36
3	863.6 to 965.5	609 to 762	45
4	965.5 to 1219.2	762 to 914.4	57
5	1219.2 to 1371.6	914.4 to 1066.8	70
6	1371.6 to 1524	1066.8 to 1219.2	82

CLOSER SIZE	PARALLEL ARM MINIMUM - MAXIMUM WIDTH OF DOOR(MM)		MAX. DOOR WEIGHT (KG)
	INTERIOR	EXTERIOR OR VESTIBULE DOORS	
2			
3	609 to 863.6		36
4	863.6 to 965.5	609 to 762	45
5	965.5 to 1219.2	762 to 914.4	57
6	1219.2 to 1371.6	914.4 to 1066.8	70

OPTIONAL ACCESSORIES		
DESCRIPTION	PHOTO	ARTICLE #
3 1/2 inch Tall Drop Plate Parallel Arm Mount		89-DPPA
2 9/16 inches Tall Narrow Drop Plate Regular and Top Jamb Mount		89-DPNRTJ
Friction type-Hold Open Arm		89-FHOA
Parallel Arm Bracket for 89-FHOA		PAB
Adjustable Hold Open Arm		9689-AHO
Heavy Duty Parallel Arm with Dead Stop		9689-CSA
Heavy Duty Parallel Arm with Spring Cush Dead Stop		9689-SCDS

OPTIONAL ACCESSORIES		
DESCRIPTION	PHOTO	ARTICLE #
Heavy Duty Hold Open Parallel Arm with Dead Stop		9689-CSHO
Heavy Duty Hold Open Parallel Arm With Spring Cush Dead Stop		9689-CSHO-5950
Spring Cushion for Cush or Cush Hold Open Arm		5590
Full Plastic Cover		89-FPC
Slim Plastic Cover		SPC
Sex Nuts- 4 PCS/PACK		SN
Blade Stop Spacer		1719-BSS

OPTIONAL ACCESSORIES		
DESCRIPTION	PHOTO	ARTICLE #
<p>EXTENDED LONG ROD AND SHOE LENGTH 358.8 MM TOP JAMB REVEAL: 4 INCHES THRU 8 INCHES</p>		ELRS
<p>STAINLESS STEEL COVER</p>		85-SS
<p>PARALLEL ARM BRACKET</p>		PABX