

***CE/EN ARCHITECTURAL  
IRONMONGERY***

---





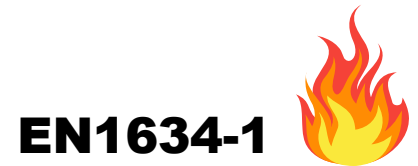

**SEALS**

**ITEM CODE: DCIS series**

**FEATURES:**

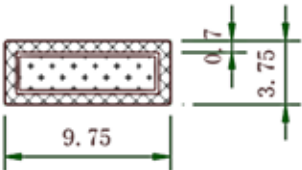
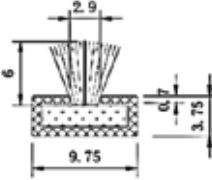
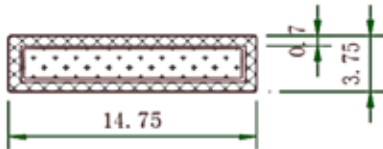
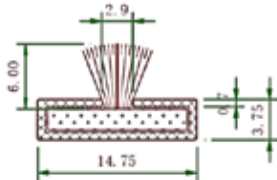
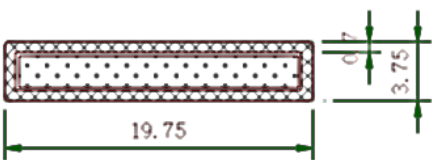
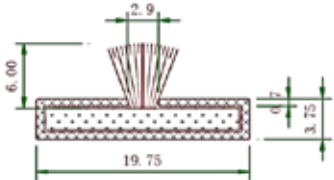

- Intumescent seals
- Area of application: For wooden or metal doors
- Material: Intumescent fire seal in a rigid PVC casing for use on fire resisting doors and doors frames.
- Available: DCIS1040B or DCIS1040W (10x4 mm), DCIS1540B or DCIS1540W (15x4 mm) and DCIS2040B or DCIS2040W (20x4 mm).
- Available with brush (smoke resistance): DCIS1040BB or DCIS1040BW (10x4 mm), DCIS1540BB or DCIS1540BW (15x4 mm), DCIS2040BB or DCIS2040BW (20x4 mm).
- Location: Mortise into the doorframe and around stiles and head.
- Fixing: Self-adhesive.
- Approval: BS EN 1634-1: 2014
- Standard finish: Brown (B) and White (W). Other finishes are available upon request.



DCIS1040B OR DCIS1040W	DCIS1040BB OR DCIS1040BW		
			
DCIS1540B OR DCIS1540W	DCIS1540BB OR DCIS1540BW		
			
DCIS2040B OR DCIS2040W	DCIS2040BB OR DCIS2040BW		
			
			

**ITEM CODE: DCIS WITH FLIPPERS SERIES**

**FEATURES:**

- Intumescent seals with double flippers
- Area of application: For wooden doors
- Material: Intumescent fire seal in a rigid PVC casing for use on fire, acoustic and smoke resistance doors and doors frames.
- Available: DCIS1040FB or DCIS1040FW (10x4 mm), DCIS1540FB or DCIS1540FW (15x4 mm) and DCIS2040FB or DCIS2040FW (20x4 mm).
- Location: Mortise into the doorframe and around stiles and head.
- Fixing: Self-adhesive.
- Approval: BS EN 1634-1: 2014
- Standard finish: Brown (B) and White (W). Other finishes are available upon request.

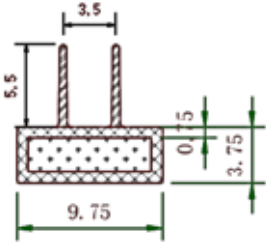
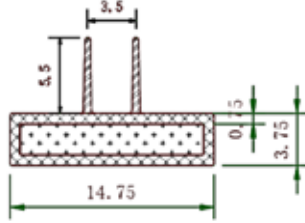
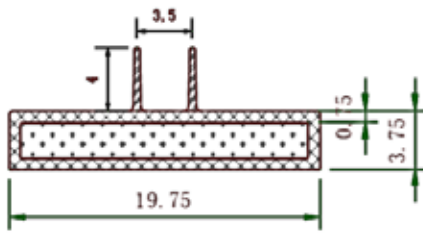

DCIS1040FB OR DCIS1040FW	DCIS1540BB OR DCIS1540BW
	
DCIS2040FB OR DCIS2040FW	
	
	

**ITEM CODE: DCS & DCSK**

**FEATURES:**

- Acoustic and smoke seals
- Area of application: For wooden or metal doors
- Material: Co-extruded PVC acoustic and smoke seals.
- Available: DCS1212 (2100 x 12 x 12 mm)
- Available with Push-in locking fit: DCSK1212 (2100 X 12 X 12 mm).
- Fixing: Self-adhesive (DCS1212) and Push-in (DCSK1212).
- Standard finish: Dark Brown (DB), White (W), Black (B), Light Brown (LB) and Clear (C).
- Other finishes are available upon request.

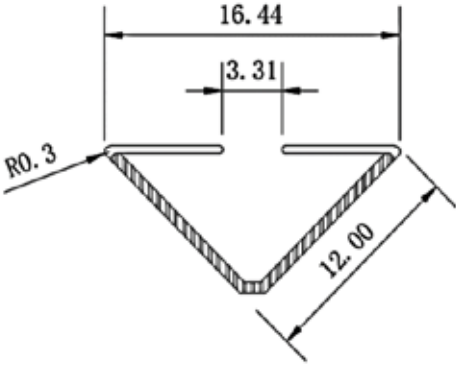
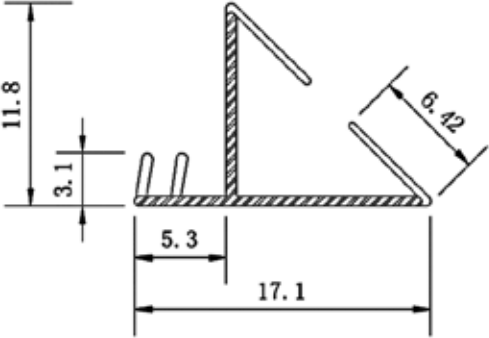

DCS1212	DCSK1212
	

**ITEM CODE: DS88 SERIES  
FIRE/SMOKE RESISTANT SILICONE GASKETS**

**EN1634-1**   
**EN1634-3**

Features:

- Area of application: For wooden or metal doors and windows.
- Material: Self Adhesive surface mounted Silicone fire/ smoke gaskets.
- Standard finish: Black. Other finishes are available upon request.
- Location: head, strike and hinges jambs.
- Excellent elasticity and compression, tear and wear, aging resistant.
- Tested successfully to EN 1634-1 (4 hours) and EN 1634-3.
- Available in 50 meters per roll

