

***CE/EN ARCHITECTURAL
IRONMONGERY***

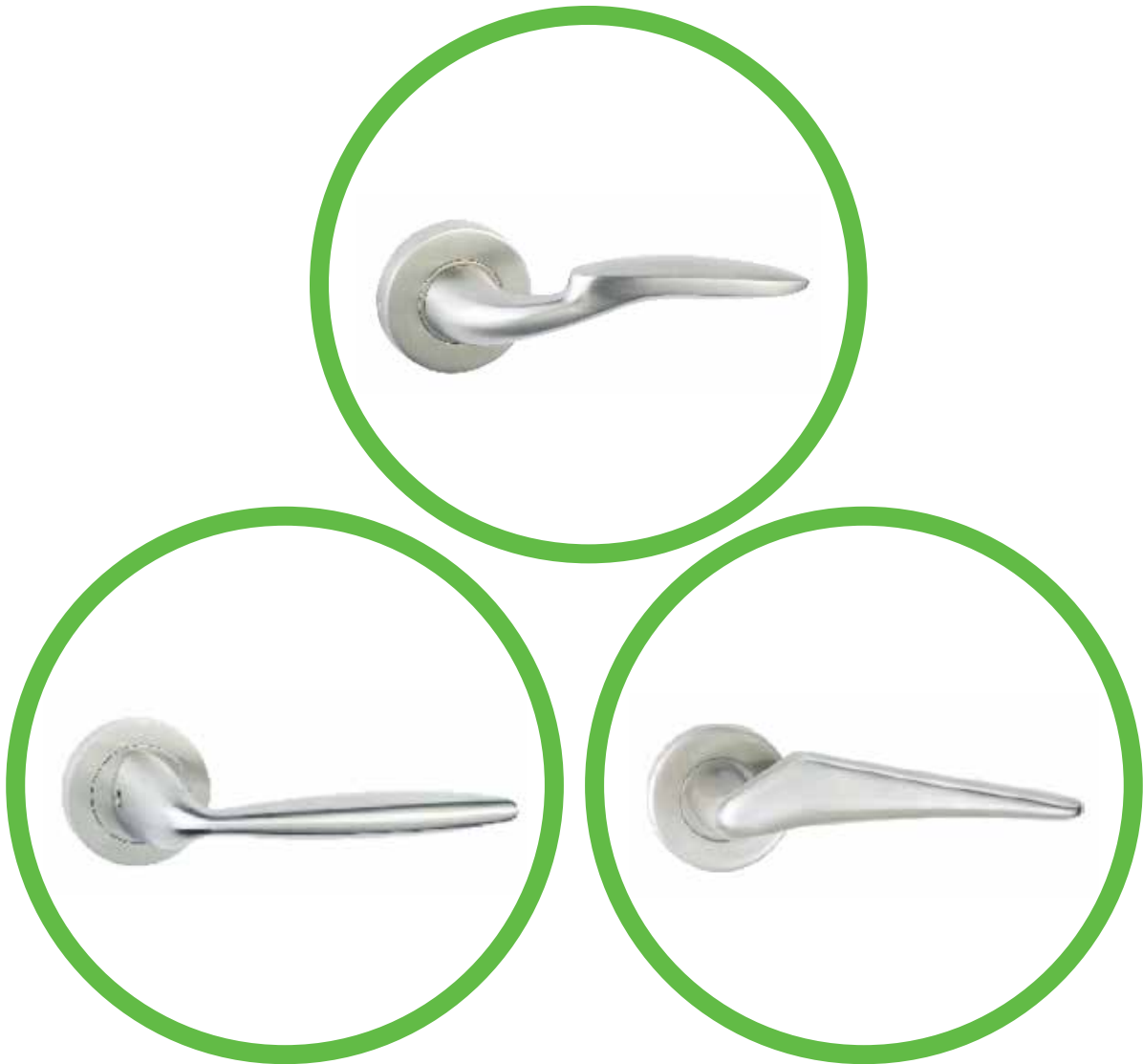

















LEVER HANDLES

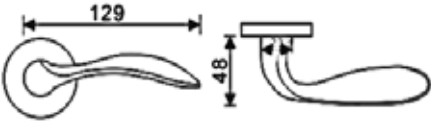
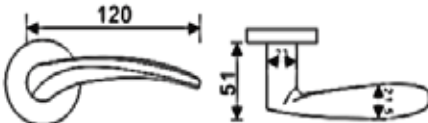
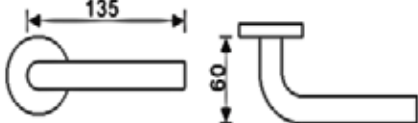



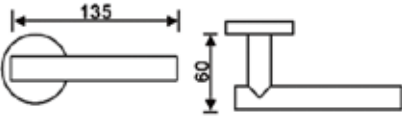
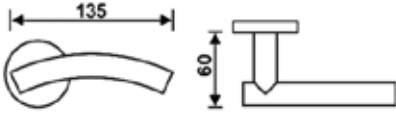
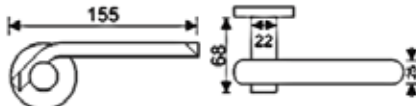



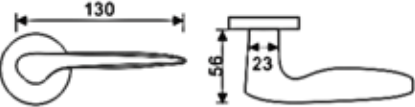
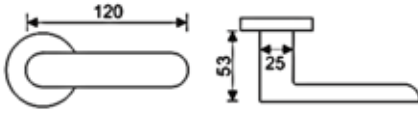
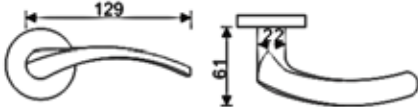

ITEM CODE: STAINLESS STEEL HOLLOW OR SOLID LEVER HANDLES ON ROUND LEVER ROSE & CYLINDER ROSE.

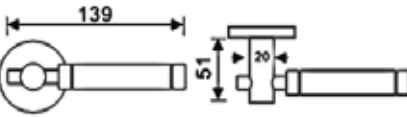
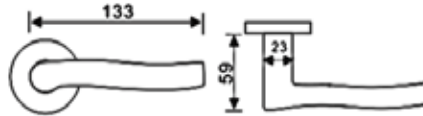
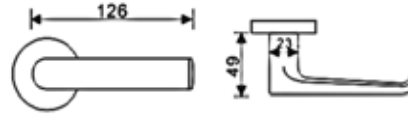



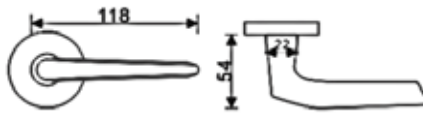
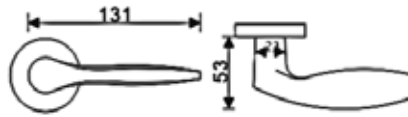



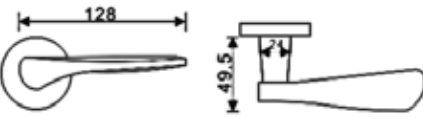
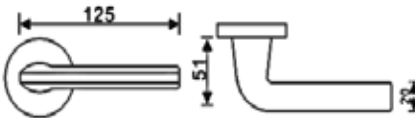
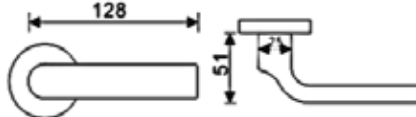

FEATURES:

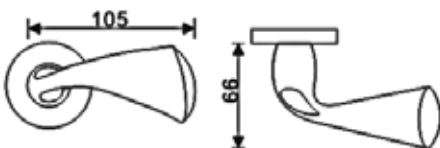
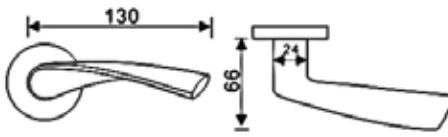
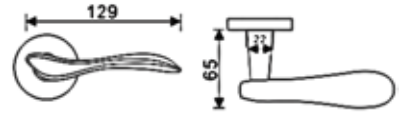

- Description: Stainless steel lever handle set on round lever rose with cylinder rose. Fully return spring assisted lever handle. The cylinder rose and lever rose features concealed fixing via an easy click.
- Material: stainless steel EN 1.4301 (type SUS304), optional in EN 1.4401 (type SUS316).
- Optional: Anti-bacterial coating. Standard finish: Satin Stainless Steel (SSS). Other finishes are available upon request.
- Door thickness: up to 50 mm (for doors thickness more than 50 mm please specify while ordering)
- 5 escutcheons/cylinder rose types. Escutcheons/cylinder roses are supplied separately.

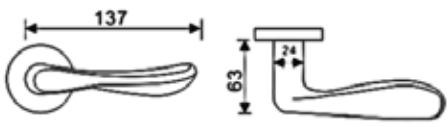
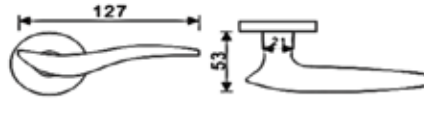
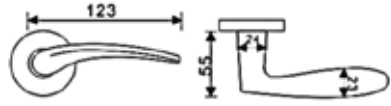



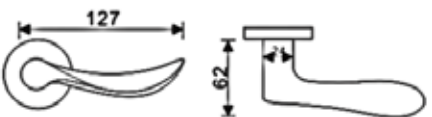
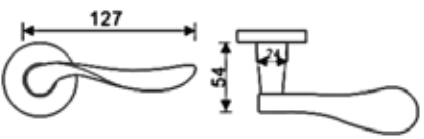
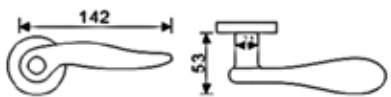



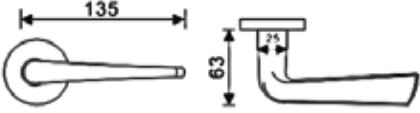
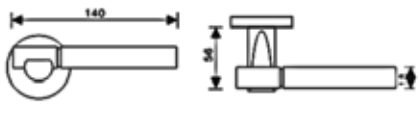
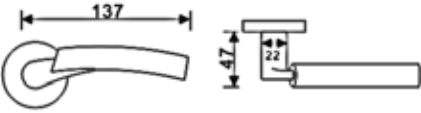

LEVER HANDLES		
<ul style="list-style-type: none"> • 1 pair of lever handle with 1 pair of lever rose (dia. 54 x 9.2 mm). • 1 pair of M4 x 60 (male) + 13.6 (female) mm bolt through (can be shortened). • 1 pair lever rose steel backplate in zinc alloy. 	<ul style="list-style-type: none"> • 1 piece of 8 x 110 mm square solid spindle. • 1 piece of Allen key. • 6 pcs wooden screws • 4 pcs metal screws – self drilling 	
T01B01	B01.E1	T01E01
<ul style="list-style-type: none"> • Dia. 52 x 8 mm • 1 pair WC turn & coin release with red/white indicator. • 1 pair rose baseplate. • 1 pc spindle of 52 mm length. • 4 pc M4 wood screw. 	<ul style="list-style-type: none"> • Dia. 54 x 9.2 mm • 1 pair Europrofile cylinder rose. • 1 pair rose baseplate. • 1 pair wood screws • 1 pair metal screws - self drilling. 	<ul style="list-style-type: none"> • Dia. 52 x 8 mm • 1 pair WC turn & coin release W/O indicator. • 1 pair rose baseplate. • 1 pc spindle of 52 mm length. • 4 pc M4 wood screw.
		
B01.E0		B01.E3
<ul style="list-style-type: none"> • Dia. 54 x 9.2 mm • 1 pair of blind rose. • 1 pair of rose baseplate. • 1 pair wood screws and 1 pair metal screws - self drilling. • Several sizes. 		<ul style="list-style-type: none"> • Dia. 54 x 9.2 mm • 1 pair of standard key rose. • 1 pair of rose baseplate. • 1 pair wood screws and 1 pair metal screws - self drilling. • Several sizes.
		

Lever handles design, supplied with B01.E1, B01.E0, B01.E3, T01B01 or T01E01		
SOLID - HS3001	SOLID - HS3002	HOLLOW - H02B01
		
		
HOLLOW - HT2B01	HOLLOW - HT3007	SOLID - HS3009
		
		
SOLID - HS3010	SOLID - HS3011	SOLID - HS3012
		
		

Lever handles design, supplied with B01.E1, B01.E0, B01.E3, T01B01 or T01E01		
SOLID – HS3013	SOLID – HS3014	SOLID – HS3018
		
		
SOLID – HS3016	SOLID – HS3015	SOLID – HS3017
		
		
SOLID – HS3019	SOLID – HS3020	SOLID – HS3021
		
		

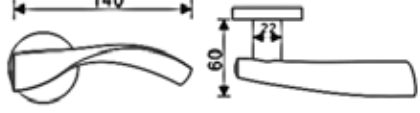
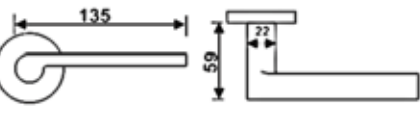
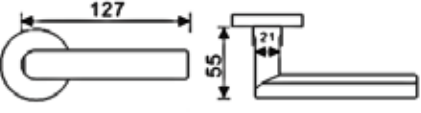
Lever handles design, supplied with B01.E1, B01.E0, B01.E3, T01B01 or T01E01		
SOLID – HS3022	SOLID – HS3023	SOLID – HS3024
		
		
SOLID – HS3025	SOLID – HS3026	SOLID – HS3027
		
		
SOLID – HS3029	SOLID – HS3031	SOLID – HS3032
		
		



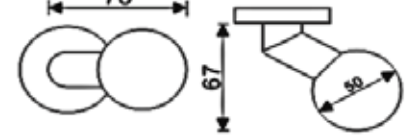
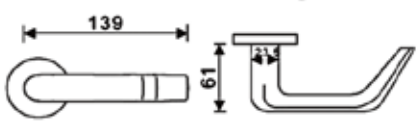
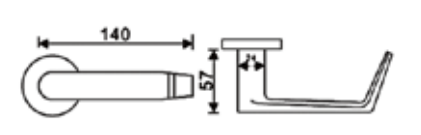

Lever handles design, supplied with B01.E1, B01.E0, B01.E3, T01B01 or T01E01		
SOLID – HS3033	SOLID – HS3035	HOLLOW – H01B01
		
		
SOLID – HS3059	SOLID – H15	HOLLOW – H04
		
		
HOLLOW – HL42	HOLLOW – HL2B01	SOLID – H65
		
		

Lever handles design, supplied with B01.E1, B01.E0, B01.E3, T01B01 or T01E01		
SOLID – H14	SOLID – H16	SOLID – H17
		
		
SOLID – H61	SOLID – H60B01	SOLID – H66
		
		
SOLID – KS3034	SOLID – HS3067	SOLID – HS3068
		
		

ITEM CODE: STAINLESS STEEL SOLID lever handles ON SQUARE LEVER ROSES AND CYLINDER ROSE.

FEATURES:

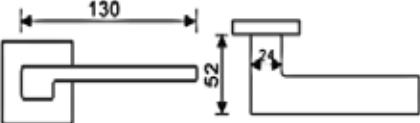
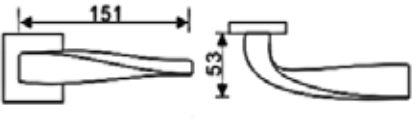
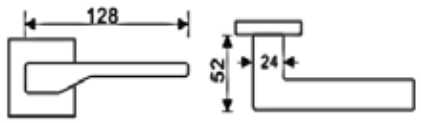

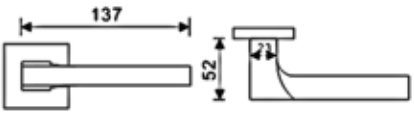

- Description: Stainless steel lever handle set on square lever rose with square cylinder rose. Fully return spring assisted lever handle. The cylinder rose and lever rose features concealed fixing via an easy click.
- Material: stainless steel EN 1.4301 (type SUS304), optional in EN 1.4401 (type SUS316).
- Optional: Anti-bacterial coating. Standard finish: Satin Stainless Steel (SSS). Other finishes are available upon request.
- Door thickness: 35 mm to 50 mm (for doors thickness more than 50 mm please specify while ordering)
- 4 escutcheons/cylinder rose types. Escutcheons/cylinder roses are supplied separately.

Lever handles design, supplied with QS01.E1, QS01.E3, QS01.E0 or QS01.E3		
SOLID – HS3003Q	SOLID – HS3004Q	SOLID – HS3005Q
		
		
SOLID – HS3028Q		
		
		

ITEM CODE: STAINLESS STEEL SOLID LEVER HANDLES ON SQUARE LEVER ROSES & SQUARE CYLINDER ROSE.

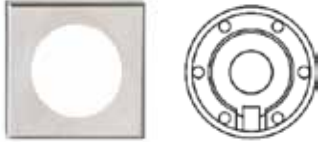
FEATURES:

- Description: Stainless steel lever handle set on square lever rose with square cylinder rose. Fully return spring assisted lever handle. The cylinder rose and lever rose features concealed fixing via a grub screw.
- Material: stainless steel EN 1.4301 (type SUS304), optional in EN 1.4401 (type SUS316).
- Optional: Anti-bacterial coating. Standard finish: Satin Stainless Steel (SSS). Other finishes are available upon request.
- Door thickness: up to 50 mm (for doors thickness more than 50 mm please specify while ordering)
- 4 escutcheons/cylinder rose types. Escutcheons/cylinder roses are supplied separately.



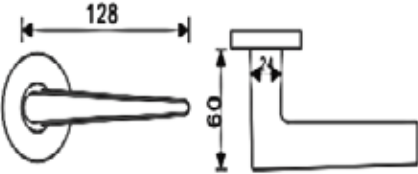

LEVER HANDLES	
<ul style="list-style-type: none"> • 1 pair of lever handle with 1 pair of square casting lever rose (53 x 53 x 8 mm). • 1 pair of M4 x 60 (male) + 13.6 (female) mm bolt through (can be shortened). • 1 pair lever casting rose steel backplate. 	<ul style="list-style-type: none"> • 1 piece of 8 x 110 mm square solid spindle. • 1 piece of Allen key. • 6 pcs wooden screws • 4 pcs metal screws – self drilling 
Q528SQE1	T101E01
<ul style="list-style-type: none"> • 53 x 53 x 8 mm • 1 pair square Europrofile cylinder rose. • 1 pair rose baseplate. • 1 pair wood screws • 1 pair metal screws - self drilling. 	<ul style="list-style-type: none"> • 50 x 50 x 10 mm • 1 pair square WC turn & coin release without indicator. • 1 pair rose baseplate. • 1 pc spindle of 52 mm length. • 4 pc M4 wood screw.
	
Q102.E0	Q102.E3
<ul style="list-style-type: none"> • 53 x 53 x 8 mm • 1 pair of Blind Square rose. • 1 pair of rose baseplate. • 1 pair wood screws and 1 pair metal screws - self drilling. • Several sizes. 	<ul style="list-style-type: none"> • 53 x 53 x 8 mm • 1 pair of standard Key Square rose. • 1 pair of rose baseplate. • 1 pair wood screws and 1 pair metal screws - self drilling. • Several sizes.
	

Lever handles design, supplied with Q528SQE1, T101E01, Q102.E0 or Q102.E3		
SOLID – H129SQ		
		
		

ITEM CODE: STAINLESS STEEL HOLLOW LEVER HANDLES ON SQUARE LEVER ROSE & CYLINDER ROSE.

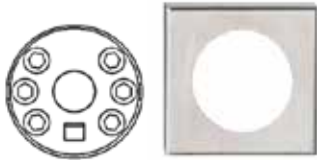
FEATURES:

- Description: Stainless steel lever handle set on square lever rose with cylinder rose. Fully return spring assisted lever handle. The cylinder rose and lever rose features concealed fixing via an easy click.
- Material: stainless steel EN 1.4301 (type SUS304), optional in EN 1.4401 (type SUS316).
- Optional: Anti-bacterial coating. Standard finish: Satin Stainless Steel (SSS). Other finishes are available upon request.
- Door thickness: up to 50 mm (for doors thickness more than 50 mm please specify while ordering).
- 4 escutcheons/cylinder roses types. Escutcheons/cylinder roses are supplied separately.



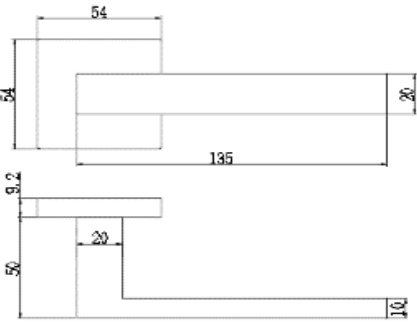



LEVER HANDLES	
<ul style="list-style-type: none"> • 1 pair of lever handle with 1 pair of square lever rose (54 x 54 x 9.2 mm). • 1 pair of M4 x 60 (male) + 13.6 (female) mm bolt through (can be shortened). • 1 pair lever rose steel backplate in zinc alloy. 	<ul style="list-style-type: none"> • 1 piece of 8 x 110 mm square solid spindle. • 1 piece of Allen key. • 6 pcs wooden screws • 4 pcs metal screws – self drilling 
B01Q.E1	T101E01
<ul style="list-style-type: none"> • 54 x 54 x 9.2 mm • 1 pair square Europrofile cylinder rose. • 1 pair rose baseplate. • 1 pair wood screws • 1 pair metal screws - self drilling. 	<ul style="list-style-type: none"> • 50 x 50 x 10 mm • 1 pair square WC turn & coin release without indicator. • 1 pair rose baseplate. • 1 pc spindle of 52 mm length. • 4 pc M4 wood screw.
	
B01Q.E0	B01Q.E3
<ul style="list-style-type: none"> • 54 x 54 x 9.2 mm • 1 pair of blind square rose. • 1 pair of rose baseplate. • 1 pair wood screws and 1 pair metal screws - self drilling. • Several sizes. 	<ul style="list-style-type: none"> • 54 x 54 x 9.2 mm • 1 pair of standard key square rose. • 1 pair of rose baseplate. • 1 pair wood screws and 1 pair metal screws - self drilling. • Several sizes.
	



Lever handles design, supplied with B01Q.E1, T101E01 B01Q.E0 or B01Q.E3		
SOLID – HT3008Q		
		
		

ITEM CODE: STAINLESS STEEL HANDLES ON ROUND THREADED HANDLE ROSE AND THREADED CYLINDER ROSE.

FEATURES:

- Description: Stainless steel handle set on round threaded handle rose and cylinder rose. Fully return spring assisted handle. The cylinder and lever roses features concealed fixing on both sides by a threaded fixing.
- Material: stainless steel EN 1.4301 (type SUS304), optional in EN 1.4401 (type SUS316).
- Optional: Anti-bacterial coating. Standard finish: Satin Stainless Steel (SSS). Other finishes are available upon request.
- Door thickness: up to 70 mm (for doors thickness more than 70 mm please specify while ordering)
- 5 escutcheons/cylinder rose types. Escutcheons/cylinder roses are supplied separately.

HANDLES		
<ul style="list-style-type: none"> • 1 pair of handle with 1 pair of handle threaded rose (dia. 52 x 10 mm). • 1 pair of M4 x 60 (male) + 13.6 (female) mm bolt through (can be shortened). • 1 pair movable mechanism steel backplate. 	<ul style="list-style-type: none"> • 1 piece of 8 x 70 mm square solid spindle. • 1 piece of Allen key. • 6 pcs wooden screws • 4 pcs metal screws – self drilling 	
T01B01	B101.E01	T01E01
<ul style="list-style-type: none"> • Dia. 52 x 8 mm • 1 pair WC turn & coin release with red/white indicator. • 1 pair rose baseplate. • 1 pc spindle of 52 mm length. • 4 pc M4 wood screw. 	<ul style="list-style-type: none"> • Dia. 54 x 10 mm • 1 pair Europrofile threaded cylinder rose. • 1 pair rose baseplate. • 1 pair wood screws • 1 pair metal screws - self drilling. 	<ul style="list-style-type: none"> • Dia. 52 x 8 mm • 1 pair WC turn & coin release W/O indicator. • 1 pair rose baseplate. • 1 pc spindle of 52 mm length. • 4 pc M4 wood screw.
		
B101.E0		B101.E3
<ul style="list-style-type: none"> • Dia. 54 x 10 mm • 1 pair of blind rose. • 1 pair of rose baseplate. • 1 pair wood screws and 1 pair metal screws - self drilling. • Several sizes. 		<ul style="list-style-type: none"> • Dia. 54 x 10 mm • 1 pair of standard key rose. • 1 pair of rose baseplate. • 1 pair wood screws and 1 pair metal screws - self drilling. • Several sizes.
		

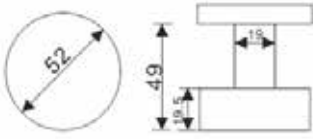
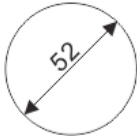
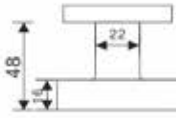
Lever handles design, supplied with B101.E01, B101.E3, B101.E0, T01B01 or T01E01		
SOLID – KH3006	SOLID – KS3030	
		
		

ITEM CODE: H01B32.E1

STAINLESS STEEL HOLLOW LEVER HANDLE ON SQUARE BACKPLATE.

FEATURES:

- Description: Stainless steel lever handle set on square backplate. Fully return spring assisted lever handle.
- Material: stainless steel EN 1.4301 (type SUS304), optional in EN 1.4401 (type SUS316).
- Door thickness: 35 mm to 70 mm (for doors thickness more than 70 mm please specify while ordering).
- 1 pair of lever handle on backplate 170 x 170 x 1.5 mm, 1 piece of 8 x 105 mm square solid spindle.
- 1 pc. of Allen key, 8 pcs wooden screws
- Standard finish: Satin Stainless Steel (SSS).
- Other finishes are available upon request.

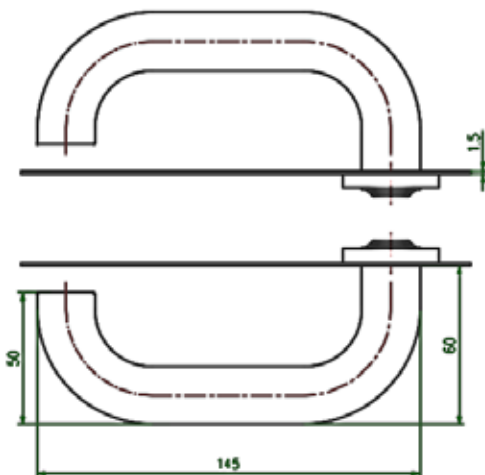
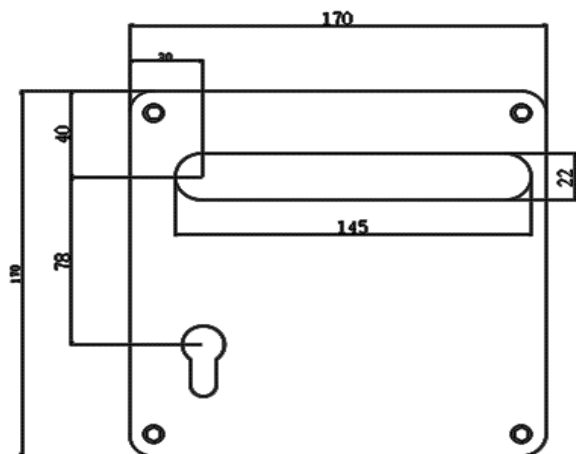
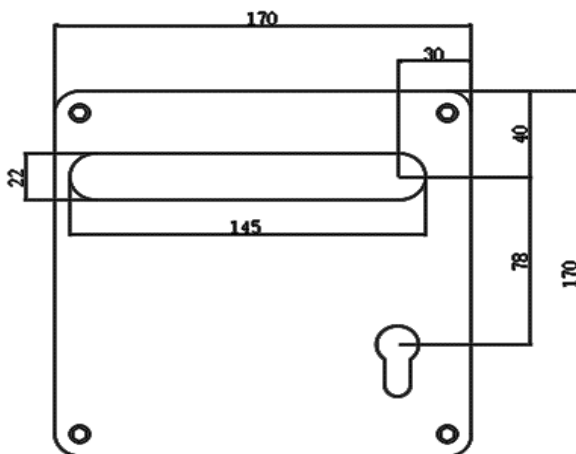

ITEM CODE: HT1036CR

STAINLESS STEEL HOLLOW LEVER HANDLE ON OVAL LEVER ROSE.

FEATURES:

- Description: Stainless steel hollow lever handle set on oval lever rose 70 x 30 x 10 mm. Fully return spring assisted lever handle.
- Material: stainless steel EN 1.4301 (type SUS304), optional in EN 1.4401 (type SUS316).
- Door thickness: 35 mm to 60 mm (for doors thickness more than 60 mm please specify while ordering).
- 1 pair of lever handle on oval lever rose, 1 piece of 8 x 110 mm square solid spindle.
- 1 piece of Allen key, 2 pieces of bolt through M4X65, fixing wood screws.
- Standard finish: Satin Stainless Steel (SSS).
- Other finishes are available upon request.

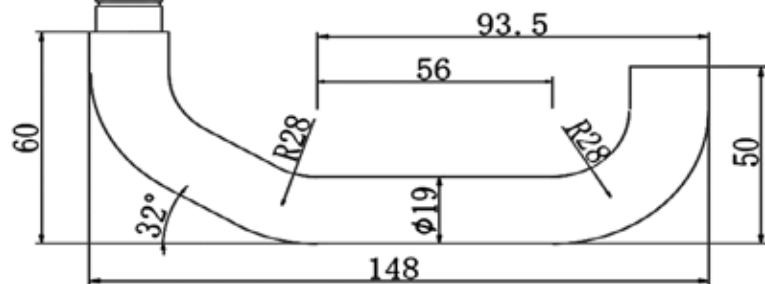
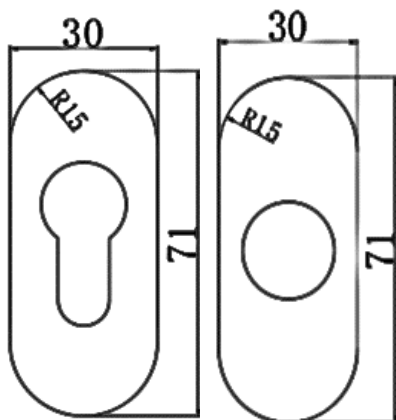

ITEM CODE: H34B01.E1

STAINLESS STEEL HOLLOW LEVER HANDLE ROUND LEVER ROSE.

FEATURES:

- Description: Stainless steel hollow lever handle set on lever rose. Fully return spring assisted lever handle.
- Material: stainless steel EN 1.4301 (type SUS304), optional in EN 1.4401 (type SUS316).
- Door thickness: 35 mm to 45 mm (for doors thickness more than 45 mm please specify while ordering).
- 1 pair of lever handle on lever rose dia. 52 x 7 mm, 1 piece of 8 x 90 mm square solid spindle.
- 1 piece of Allen key, 2 pieces of bolt through M4X65, 12 pieces fixing wood screws.
- Optional: Available with threaded rose (item code: H34B01.E1 D52X7)
- Standard finish: Satin Stainless Steel (SSS).
- Other finishes are available upon request.

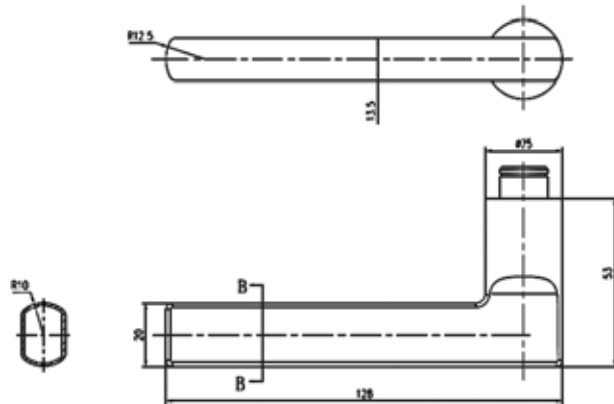

ITEM CODE: H01B03T1-78L

STAINLESS STEEL HOLLOW LEVER HANDLE ON BACKPLATE.

FEATURES:

- Description: Stainless steel hollow lever handle set on backplate 170 x 170 x 1.5 mm with turn and release & indicator. Fully return spring assisted lever handle.
- Material: stainless steel EN 1.4301 (type SUS304), optional in EN 1.4401 (type SUS316).
- Door thickness: 35 mm to 45 mm (for doors thickness more than 45 mm please specify while ordering).
- Centre to centre: 78 mm
- Left handed.
- 1 pair of lever handle dia. 22 x 145 mm, 1 piece of 8 x 58 mm square solid spindle.
- 1 pc. of Allen key, 8 pcs wooden screws
- Standard finish: Satin Stainless Steel (SSS). Other finishes are available upon request.

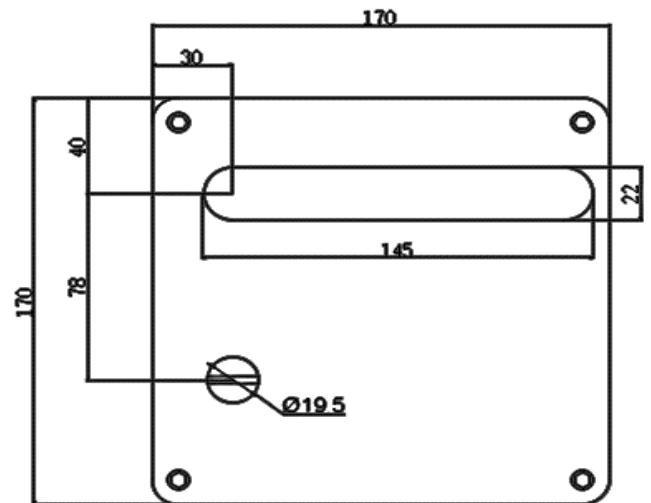
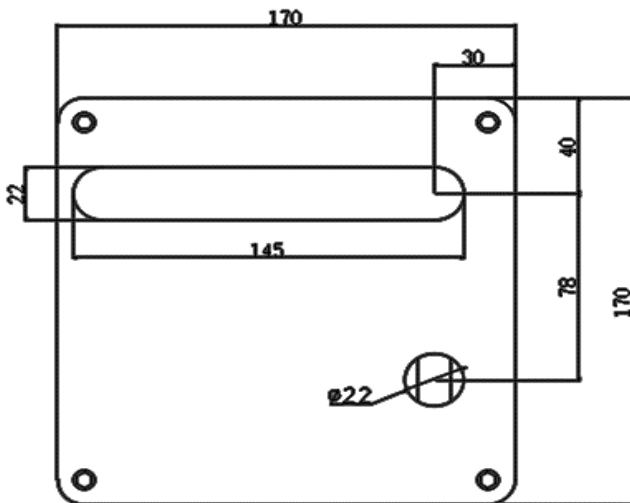

ITEM CODE: H01B03T1-78R

STAINLESS STEEL HOLLOW LEVER HANDLE ON BACKPLATE.

FEATURES:

- Description: Stainless steel hollow lever handle set on backplate 170 x 170 x 1.5 mm with turn and release & indicator. Fully return spring assisted lever handle.
- Material: stainless steel EN 1.4301 (type SUS304), optional in EN 1.4401 (type SUS316).
- Door thickness: 35 mm to 45 mm (for doors thickness more than 45 mm please specify while ordering).
- Centre to centre: 78 mm
- Right handed.
- 1 pair of lever handle dia. 22 x 145 mm, 1 piece of 8 x 58 mm square solid spindle.
- 1 pc. of Allen key, 8 pcs wooden screws
- Standard finish: Satin Stainless Steel (SSS). Other finishes are available upon request.

