

ANSI/UL ARCHITECTURAL HARDWARE

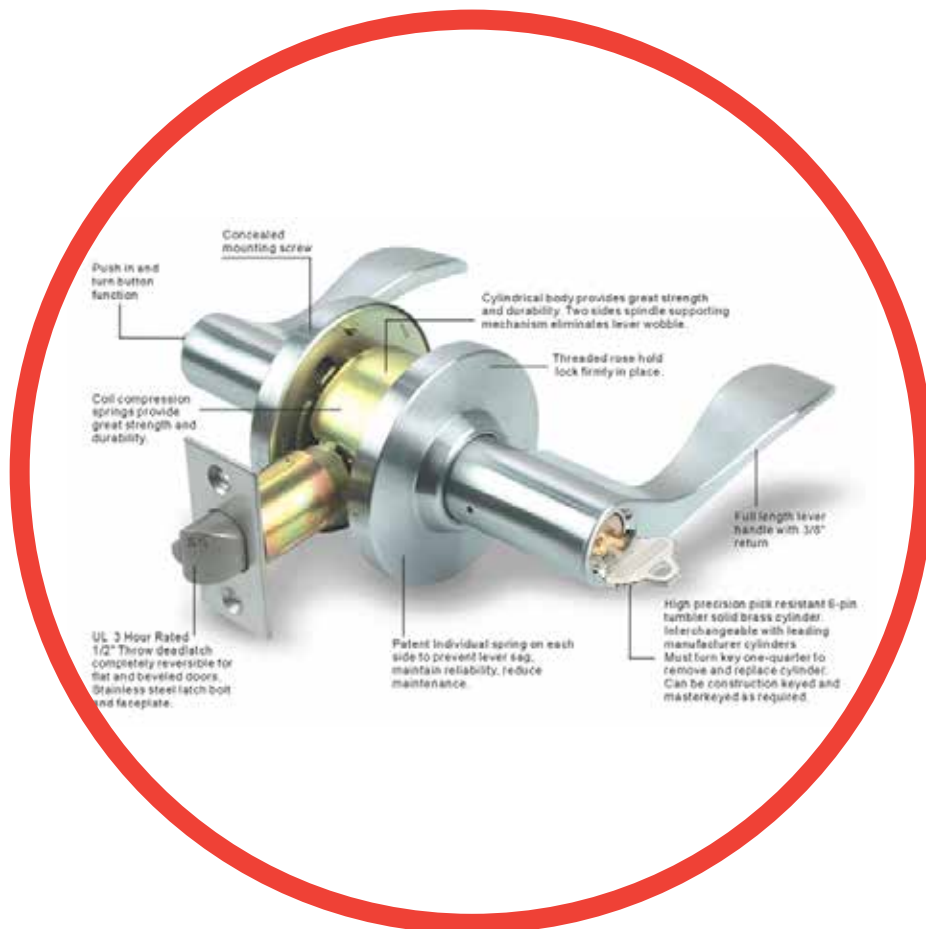

CYLINDRICAL BORED LOCKS

ITEM CODE: SERIES 4100 & 4000





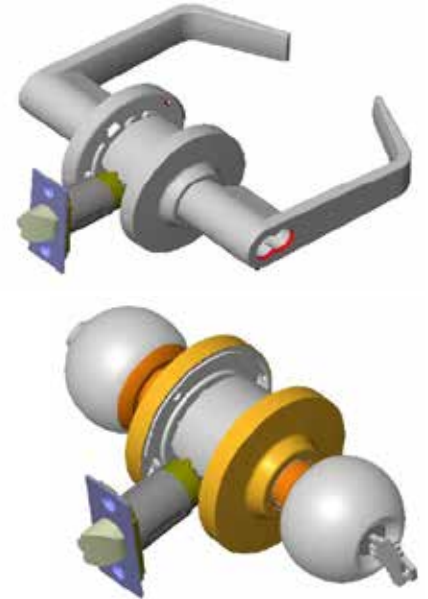
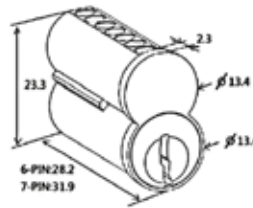

FEATURES:

- Heavy duty cylindrical bored locks.
- UL listed. UL10C 3 hours fire rated.
- Compliant to meet ANSI A156.2 grade 2.
- ADA compliant (American with Disabilities Act), ANSI A117 (Accessible and Usable Buildings and Facilities).
- Non-handed for simple installation.
- Accepts SFIC core, optional key-in-lever
- Designed for doors thickness 44 mm standard.
- Standard backset: 70 mm only.
- Latchbolt 12.7 mm throw in stainless steel.
- Strike: ANSI strike.
- Available in knob or lever handle.
- Series 4100 material base: lever is zinc, rose is SUS304.
- Series 4000 material base: SUS304
- Cylinders and keys: Small format Interchangeable core (SFIC) cylinders, 6 or 7 pins SFIC cylinders with 2 operate nickel plated standard keys + 1 nickel plated control key.
- SFIC core on selected models, several ANSI functions are available
- Construction keys, master key and keyways are available, Standard finish: 626 (satin chromium plated) standard, Other finishes are available upon request.





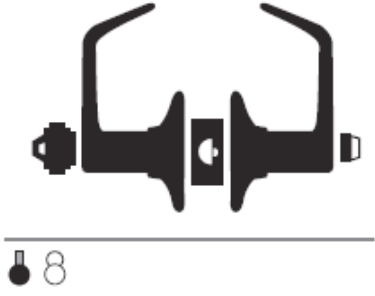
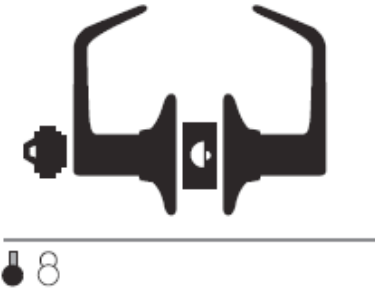
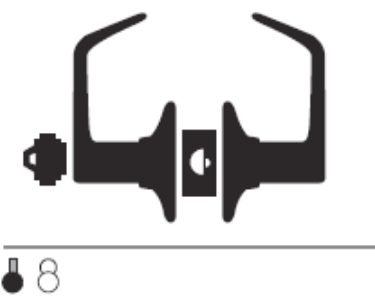

SERIES 4100-F81-AH471	SERIES 4000-F81-KNOB

CYLINDRICAL BORED LOCKS

OUTSIDE/INSIDE - PASSAGE (ANSI F75)	OUTSIDE/INSIDE – PRIVACY (ANSI F76)
	
<ul style="list-style-type: none"> • Both lever always unlocked 	<ul style="list-style-type: none"> • Push-button locking • Can be opened from outside with small narrow tool • Turning the inside lever releases button
OUTSIDE/INSIDE – ENTRY (F81)	OUTSIDE/INSIDE – CLASSROOM (F84)
	
<ul style="list-style-type: none"> • Outside lever locked and unlocked by key or by turn-button on inside lever • Inside lever always unlocked 	<ul style="list-style-type: none"> • Outside lever locked and unlocked by key • Inside lever always unlocked
OUTSIDE/INSIDE – STOREROOM (F86)	OUTSIDE/INSIDE – DUMMY
	
<ul style="list-style-type: none"> • Outside lever fixed • Entrance by key only • Inside lever always unlocked 	<ul style="list-style-type: none"> • Dummy trim for one side of door • Used for door pull or as matching inactive trim

CYLINDRICAL BORED LOCKS

AVAILABLE TRIM		
		
AH471	AH472	AH473
		
AH474	AH475	AH476